

Data Sheet



Article number: 021500700092

Description: Sealing Clamp S 92 W5

Measures

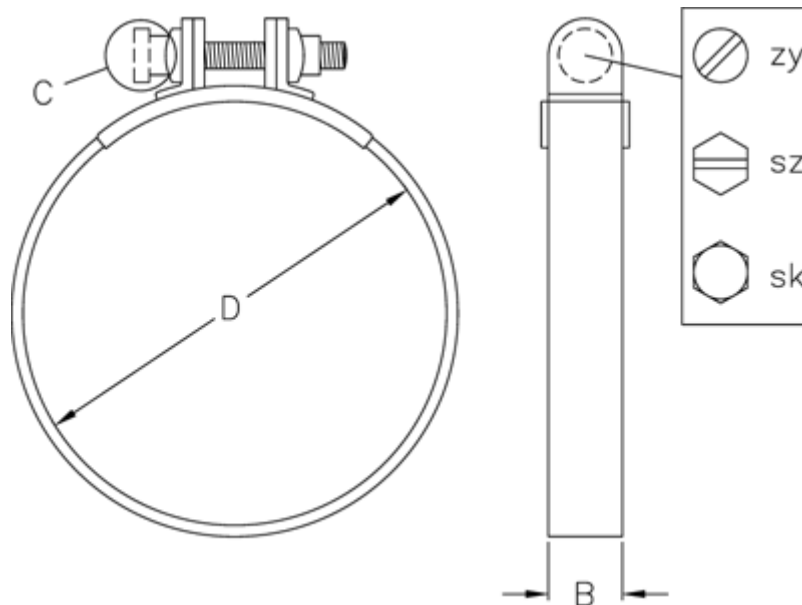

C (screw type) = SZ

Diameter D = 92

Width B = 20